



INFORMAZIONE E FX TRADING



THOMSON REUTERS

LE SFIDE DELLE TESORERIE

PRE-TRADE: PRESA DI DECISIONE DI TRADING

GESTIONE DEL RISCHIO

ACCESSO AL MERCATO E LIQUIDITA

RAPIDITA' E STP

EFFICENZA DI COMPLIANCE,
COMUNICAZIONE E COLLABORAZIONE

STRUMENTI DI ALTA QUALITA PER LE TESORERIE

- Strumenti che forniscono informazioni di qualità in modo rapido ed intelligente
- Strumenti di trading con accesso a pools di liquidità molteplici
- Strumenti compliant alle nuove regulations

ESIGENZE DELLE TESORERIE

1 CONNETTIVITA

2 PRODUTTIVITA

3 REGULATIONS

4 COSTI TRANSAZIONALI

5 COLLABORATION

CONNETTIVITA

The screenshot displays the FXall trading platform interface. At the top, there's a navigation bar with 'FX Rates' and 'FX Options' tabs. Below this, a 'Market Data' section shows various currency pairs and their rates. A 'News' section is visible, featuring a headline: 'GERMANY CAN'T STOP EURO ZONE SINKING INTO LONGEST RECESSION'. The main part of the screen is a trade execution window for EUR/USD, showing a 'Sell EUR' order for 1,000,000.00 at a rate of 1.19519. Below the order entry, there's a table of liquidity providers (BANK1 to BANK5) with their respective bid and ask rates. At the bottom, there's a 'Deal Log' section showing a list of executed trades with details like status, type, pair, value, date, account, BIS, Coy, Amount, Rate, Pts, All-in, and Provider.

- Ricerca facile e tempestiva delle informazioni con l'aiuto di nuovi search engine che consentono una ricerca "intelligente" e multi risultato: dai prezzi alle news, alle persone.
- Informativa di prezzo supportata da tools analitici quali grafici e calcolatori, che a loro volta conducono a soluzioni transazionali.
- Apertura di sistemi che consente utilizzo dei dati e delle news
- Accesso alla liquidità che in questi ultimi anni ha visto una diversificazione in bacini di liquidità molteplici e differenti
- Accesso ai mercati emergenti
- Connessione ai market participants
- Identificazione di nuove opportunità

PRODUTTIVITA

Strutturare tutto il workflow: Pre-Trade/Trade/Post Trade in termini di automazione, mitigazione dei rischi, rapidità e razionalizzazione dei costi

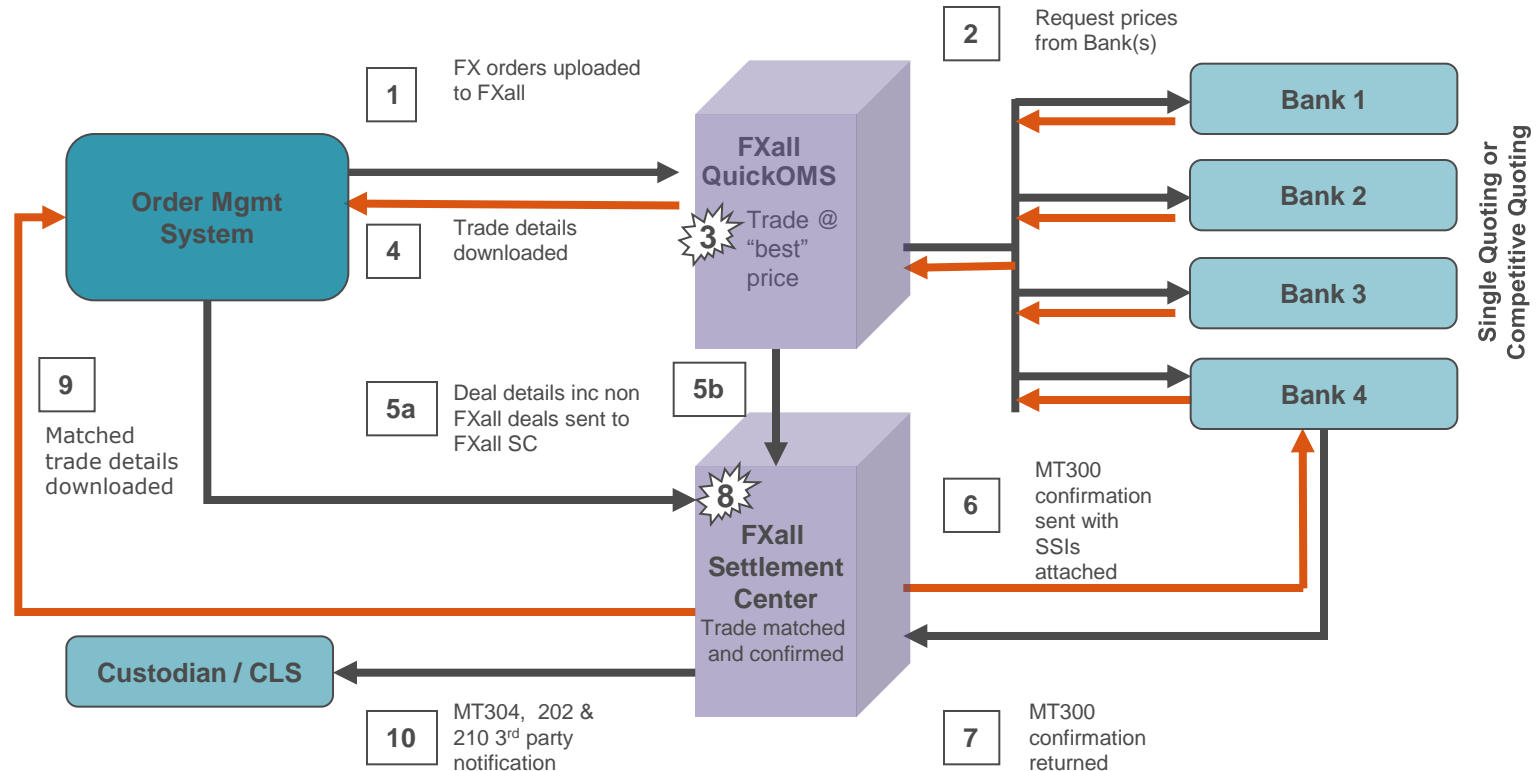

PRODUTTIVITA

Order Details - EUR.USD - Algo

Limit Market Stop Algo

EUR.USD Amount 50,000,000

BUY SELL

EUR USD

Venue: BANK1 Account: Account1

Strategy TWAP

Start Time 14:00:00

End Time 14:30:00

Execution Style Aggressive

Price 1.25

When Limited Expedite

Limit Avg Yes

Close Place Order

- Gestire l'aumentata volatilità dei mercati
- Bassa Latenza
- Algo Trading
- Fixing trading

GBP 295

BANK1

BANK1 BANK2 BANK3

Accept Accept Accept

DIFF(USD)		0		126		225		
SPOT		0.86650		0.86652		0.86654		
VALUE DATE	B/S	NET AMOUNT	PTS	ALL IN	PTS	ALL IN	PTS	ALL IN
27-Jun-11	B	1,000,000.00	-3.48	0.8661520	-3.46	0.8661740	-3.46	0.8661940
27-Jul-11	S	369,254.00	-7.13	0.8657870	-7.11	0.8658089	-7.12	0.8658279
30-Aug-11	B	630,746.00	-12.00	0.8653000	-12.01	0.8653190	-12.01	0.8653390
28-Nov-11	B	1,000,000.00	-24.80	0.8640200	-24.89	0.8640310	-24.81	0.8640590
27-Feb-12	B	1,000,000.00	-37.85	0.8627150	-37.75	0.8627450	-37.96	0.8627440

REGULATIONS

Sviluppi rapidi su sistemi in linea con la regulations

View	Status	Type	ID	CCY Pair	Value ... ▲	SEF	Account	Role	Sec. Conv.	B/S	Dealt
	All			All			All				
▶	Ready	Forward		EUR.USD	16-Sep-13		SEF_Account2			S	EUR
▶	Partially Executed	Forward		EUR.USD	16-Sep-13		SEF_Account3			S	EUR
▶	Ready	NDF		USD.BRL	16-Sep-13	SEF	SEF_Account3	PRIN		S	USD
▶	Ready	Forward	JULG11	USD.CAD	16-Sep-13		Account2			B	USD
▶	Ready	Swap	JULG17	USD.CAD	2 Dates		Account2			S	USD
▶	Ready	NDF		USD.BRL	17-Sep-13	SEF	SEF_Account1	AGCY		S	USD
▶	Ready	NDF		USD.BRL	17-Sep-13	SEF	SEF_Account1	AGCY		S	USD
▶	Ready	NDF		USD.BRL	17-Sep-13	OFF	SEF_Account2			S	USD
▶	Ready	Forward	JULG15	GBP.CAD	17-Sep-13		Account1			S	GBP
▶	Ready	Forward	JULG16	AUD.CAD	17-Sep-13		Account1			B	AUD
▶	Ready	Forward	JULG7	GBP.USD	17-Sep-13		Account2			B	GBP
▶	Ready	NDF		USD.CNY	17-Oct-13	SEF	SEF_Account1	PRIN		S	USD
▶	Ready	NDF Swap		USD.BRL	2 Dates	OFF	Account1			S	BRL
▶	Ready	Forward	JULG2	EUR.USD	17-Dec-13		Account2			S	EUR

COSTI TRANSAZIONALI

SPOT

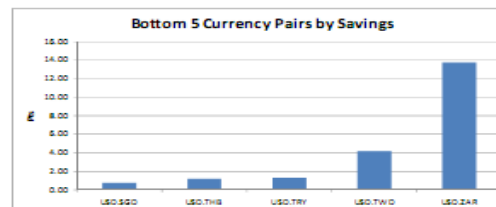
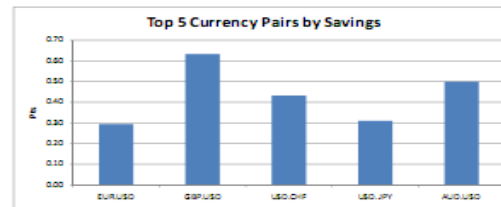
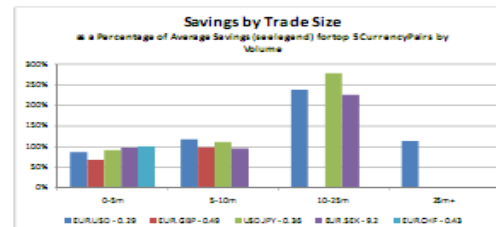
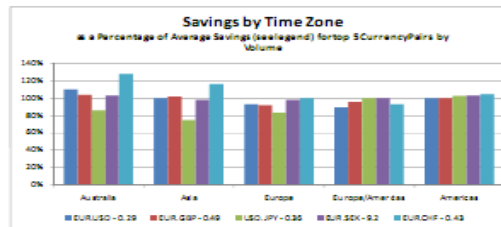
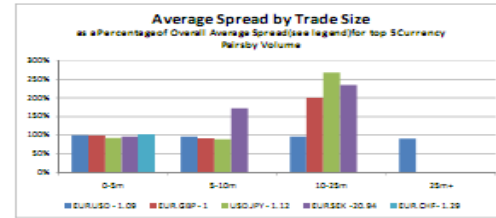
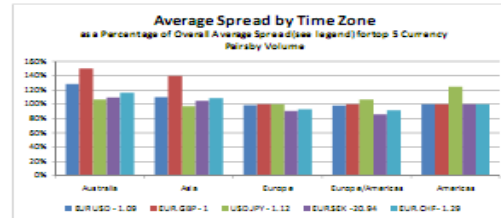
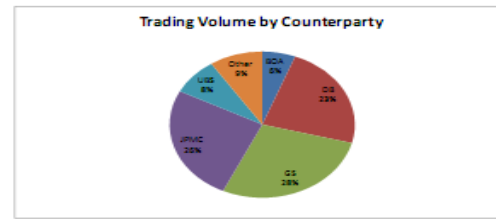
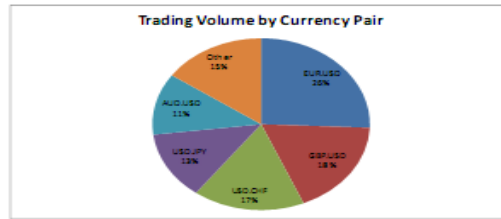

COLLABORATION

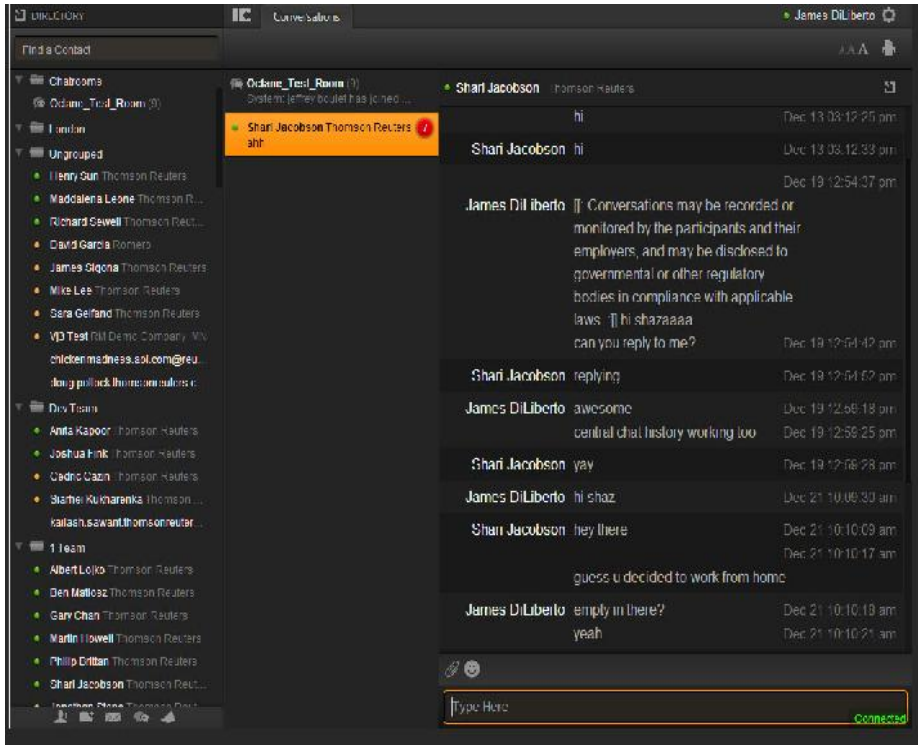

CONNESSIONI REAL-TIME:

- Con piu di 130,000 utenti Thomson Reuters Messenger

CHAT ROOMS:

- Si creano Chat Rooms per discutere su, breaking news, rumors, trade, dettagli e strategie.
- Accesso alla “Dealing Room” per informazioni interbancarie
- Accesso al “Global Markets Forum” per conoscere dati macro economici provenienti da specialisti del mercato.

INTEGRATED COMMUNICATION AND CONTENT:

- Possibilita di fare Drag and drop di grafici , notizie e dati
- Condivisione di files come annunci societari o reports particolari

GRAZIE



THOMSON REUTERS